

LOW DROP POWER SCHOTTKY RECTIFIER

Table 1: Main Product Characteristics

$I_{F(AV)}$	2 x 12.5 A
V_{RRM}	30 V
T_j	150°C
$V_F(max)$	0.45 V

FEATURES AND BENEFITS

- Very small conduction losses
- Negligible switching losses
- Extremely fast switching
- Low forward voltage drop for higher efficiency
- Low thermal resistance

DESCRIPTION

Dual Schottky rectifier suited for switch Mode Power Supply and high frequency DC to DC converters.

Packaged in D²PAK, this device is intended for use in low voltage high frequency inverters, free wheeling and polarity protection applications.

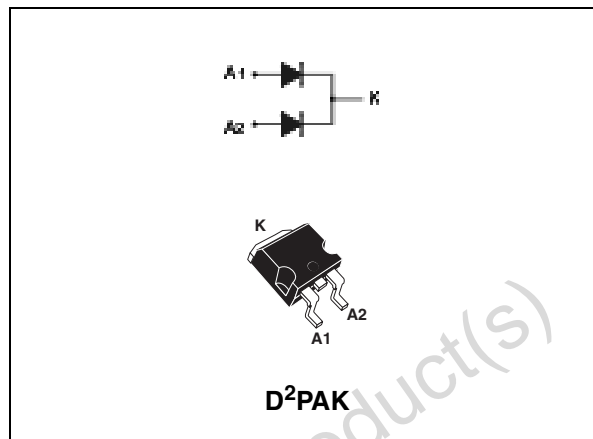

Table 2: Order Codes

Part Numbers	Marking
STPS2530CG	STPS2530CG
STPS2530CG-TR	STPS2530CG

Table 3: Absolute Ratings (limiting values, per diode)

Symbol	Parameter		Value	Unit	
V_{RRM}	Repetitive peak reverse voltage		30	V	
$I_{F(RMS)}$	RMS forward voltage		30	A	
$I_{F(AV)}$	Average forward current	$T_c = 140^\circ\text{C}$ $\delta = 0.5$	Per diode Per device	12.5 25	A
I_{FSM}	Surge non repetitive forward current		$t_p = 10\text{ms}$ sinusoidal	180	A
I_{RRM}	Peak repetitive reverse current		$t_p = 2 \mu\text{s}$ square $F=1\text{kHz}$	1	A
I_{RSM}	Non repetitive peak reverse current		$t_p = 100 \mu\text{s}$ square	2	A
P_{ARM}	Repetitive peak avalanche power		$t_p = 1 \mu\text{s}$ $T_j = 25^\circ\text{C}$	3000	W
T_{stg}	Storage temperature range		-65 to + 150	°C	
T_j	Maximum operating junction temperature *		150	°C	
dV/dt	Critical rate of rise of reverse voltage (rated V_R , $T_j = 25^\circ\text{C}$)		10000	V/ μs	

*: $\frac{dP_{tot}}{dT_j} > \frac{1}{R_{th(j-a)}}$ thermal runaway condition for a diode on its own heatsink

Table 4: Thermal Parameters

Symbol	Parameter	Value	Unit
$R_{th(j-c)}$	Junction to case	Per diode	2.2
		Total	1.3
$R_{th(c)}$	Coupling	0.3	$^{\circ}\text{C}/\text{W}$

When the diodes 1 and 2 are used simultaneously:
 $\Delta T_j(\text{diode } 1) = P(\text{diode } 1) \times R_{th(j-c)}(\text{Per diode}) + P(\text{diode } 2) \times R_{th(c)}$

Table 5: Static Electrical Characteristics (per diode)

Symbol	Parameter	Tests conditions	Min.	Typ	Max.	Unit
I_R^*	Reverse leakage current	$T_j = 25^{\circ}\text{C}$	$V_R = V_{RRM}$	0.15	1.0	mA
		$T_j = 125^{\circ}\text{C}$		80	160	
V_F^{**}	Forward voltage drop	$T_j = 25^{\circ}\text{C}$	$I_F = 12.5\text{A}$	0.47	0.53	V
		$T_j = 125^{\circ}\text{C}$		0.39	0.45	
		$T_j = 25^{\circ}\text{C}$	$I_F = 25\text{A}$	0.54	0.64	
		$T_j = 125^{\circ}\text{C}$		0.49	0.59	

Pulse test: * $t_p = 5\text{ ms}$, $\delta < 2\%$
 ** $t_p = 380\text{ }\mu\text{s}$, $\delta < 2\%$

To evaluate the conduction losses use the following equation: $P = 0.31 \times I_{F(AV)} + 0.0112 I_{F(RMS)}^2$

Figure 1: Conduction losses versus average current

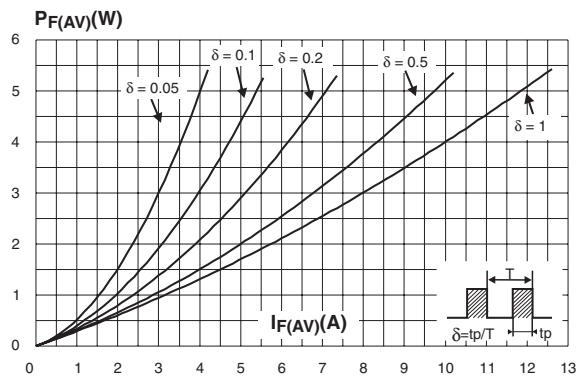

Figure 3: Normalized avalanche power derating versus pulse duration

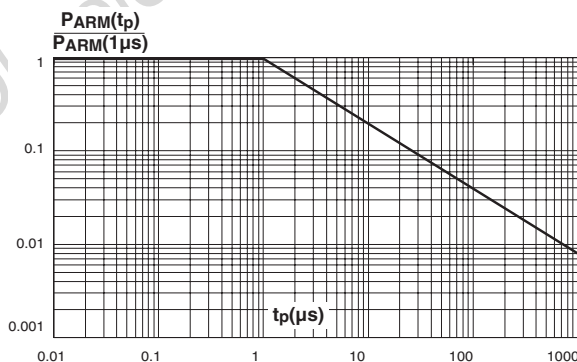

Figure 2: Average forward current versus ambient temperature (delta = 0.5, per diode)

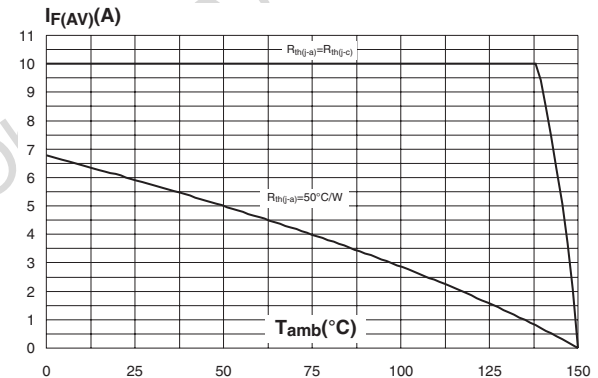

Figure 4: Normalized avalanche power derating versus junction temperature

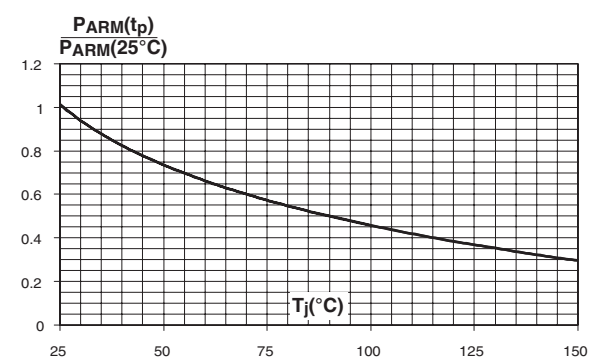

Figure 5: Non repetitive surge peak forward current versus overload duration (maximum values)

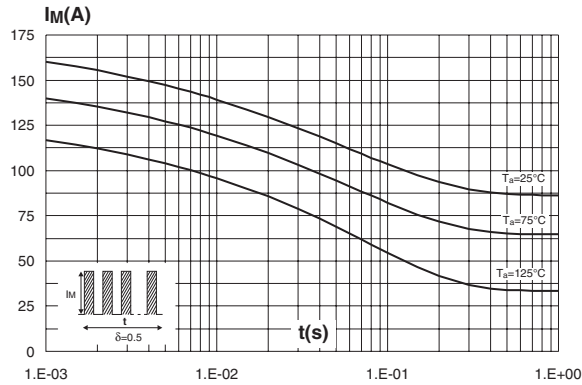

Figure 6: Relative variation of thermal impedance junction to case versus pulse duration

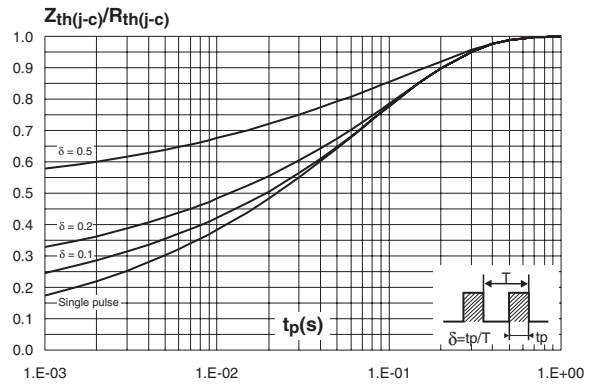

Figure 7: Reverse leakage current versus reverse voltage applied (typical values)

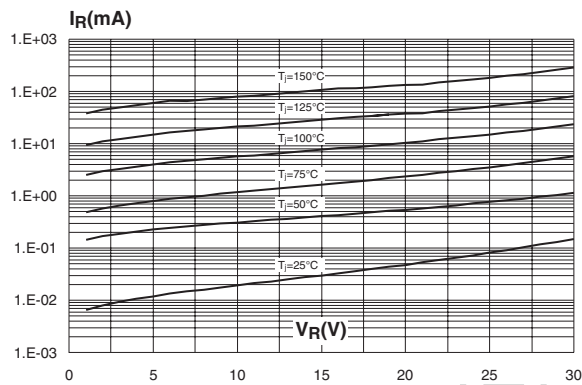

Figure 8: Junction capacitance versus reverse voltage applied (typical values)

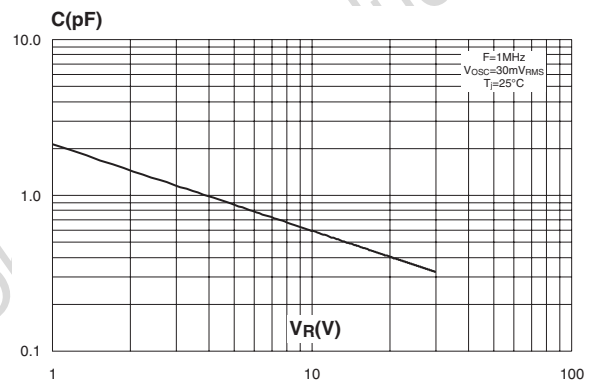

Figure 9: Forward voltage drop versus forward current

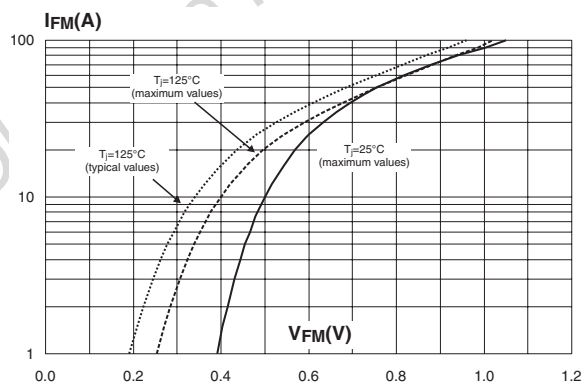

Figure 10: Thermal resistance junction to ambient versus copper surface under tab (epoxy printed board FR4, Cu = 35µm)

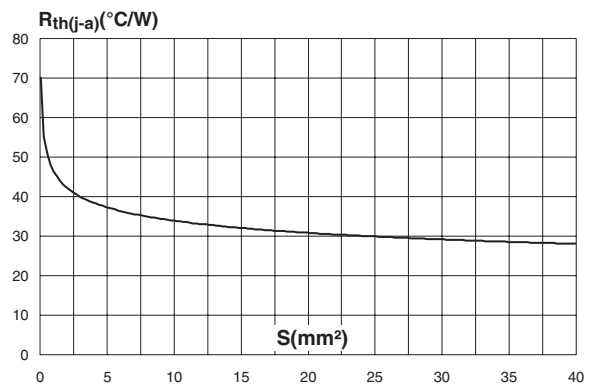

Figure 11: D²PAK Package Mechanical Data

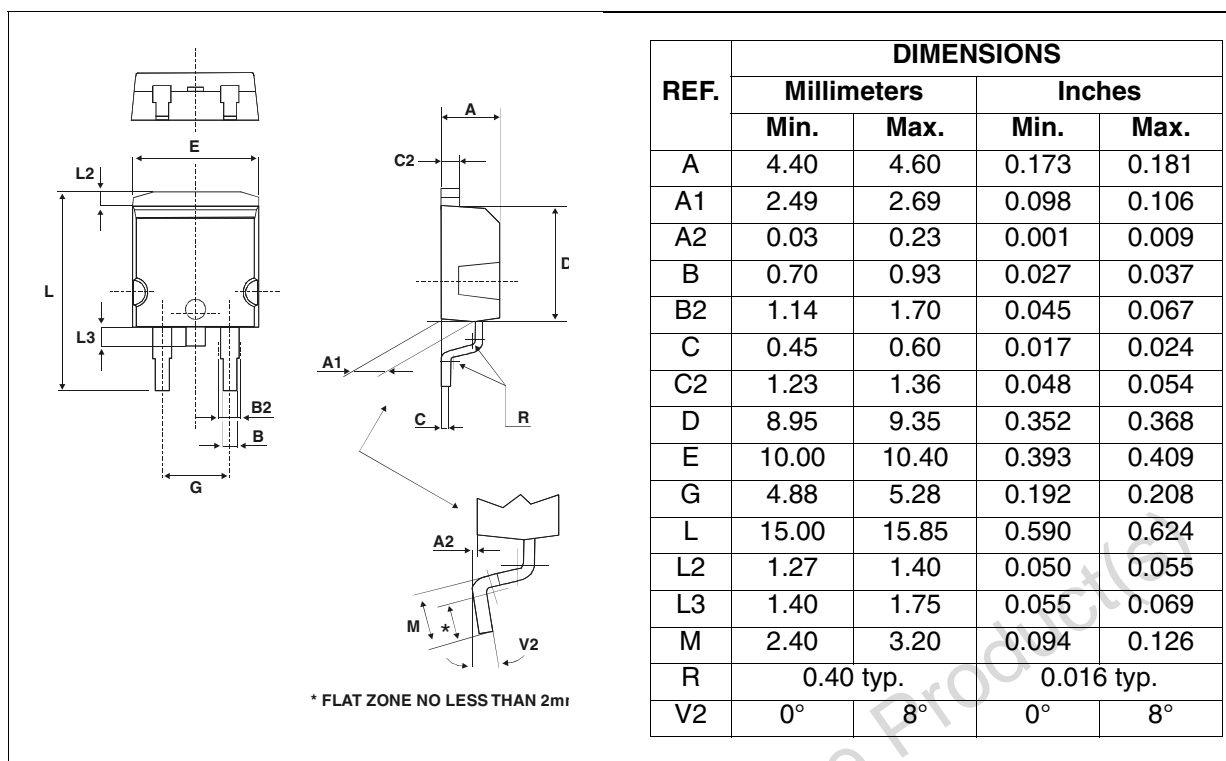

Figure 12:Foot Print Dimensions (in millimeters)

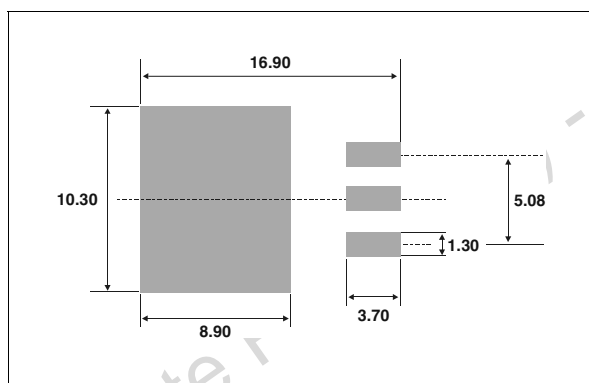

Table 6: Ordering Information

Ordering type	Marking	Package	Weight	Base qty	Delivery mode
STPS2530CG	STPS2530CG	D ² PAK	1.48 g	50	Tube
STPS2530CG-TR	STPS2530CG			1000	Tape & reel

- Epoxy meets UL94, V0

Table 7: Revision History

Date	Revision	Description of Changes
16-Apr-2005	1	First issue.

Information furnished is believed to be accurate and reliable. However, STMicroelectronics assumes no responsibility for the consequences of use of such information nor for any infringement of patents or other rights of third parties which may result from its use. No license is granted by implication or otherwise under any patent or patent rights of STMicroelectronics. Specifications mentioned in this publication are subject to change without notice. This publication supersedes and replaces all information previously supplied. STMicroelectronics products are not authorized for use as critical components in life support devices or systems without express written approval of STMicroelectronics.

The ST logo is a registered trademark of STMicroelectronics.
All other names are the property of their respective owners

© 2005 STMicroelectronics - All rights reserved

STMicroelectronics group of companies

Australia - Belgium - Brazil - Canada - China - Czech Republic - Finland - France - Germany - Hong Kong - India - Israel - Italy - Japan - Malaysia - Malta - Morocco - Singapore - Spain - Sweden - Switzerland - United Kingdom - United States of America

www.st.com